

# ENC DISTRICT 7 ROOKIE CAL RIPKEN TOURNAMENT

<u>Game #</u>	<u>Day/Date</u>	<u>Time</u>
Game 1	Thu/7-2	10:00 am
Game 2	Thu/7-2	12:00 noon
Game 3	Thu/7-2	2:30 pm
Game 4	Thu/7-2	4:30 pm
Game 5	Thu/7-2	6:30 pm
Game 6	Fri/7-3	10:00 am
Game 7	Fri/7-3	12:00 pm
Game 8	Fri/7-3	2:30 pm
Game 9	Fri/7-3	4:30 pm
Game 10	Fri/7-3	6:30 pm
Game 11	Sat/7-4	9:00 am
Game 12	Sat/7-4	11:30 am
Game 13	Sat/7-4	1:30 pm
Game 14	Sun/7-5	2:00 pm
Game 15	Sun/7-5	4:30 pm

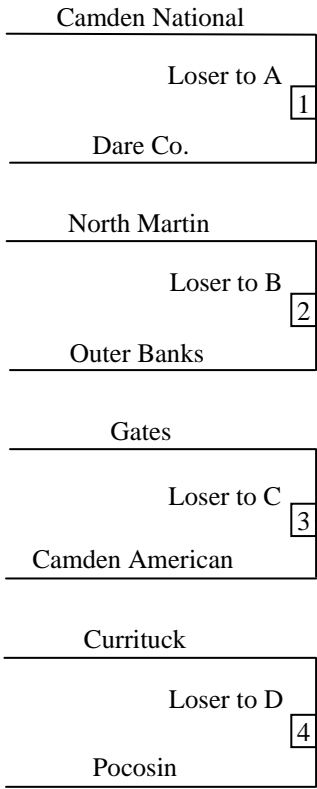

## Loser's Bracket

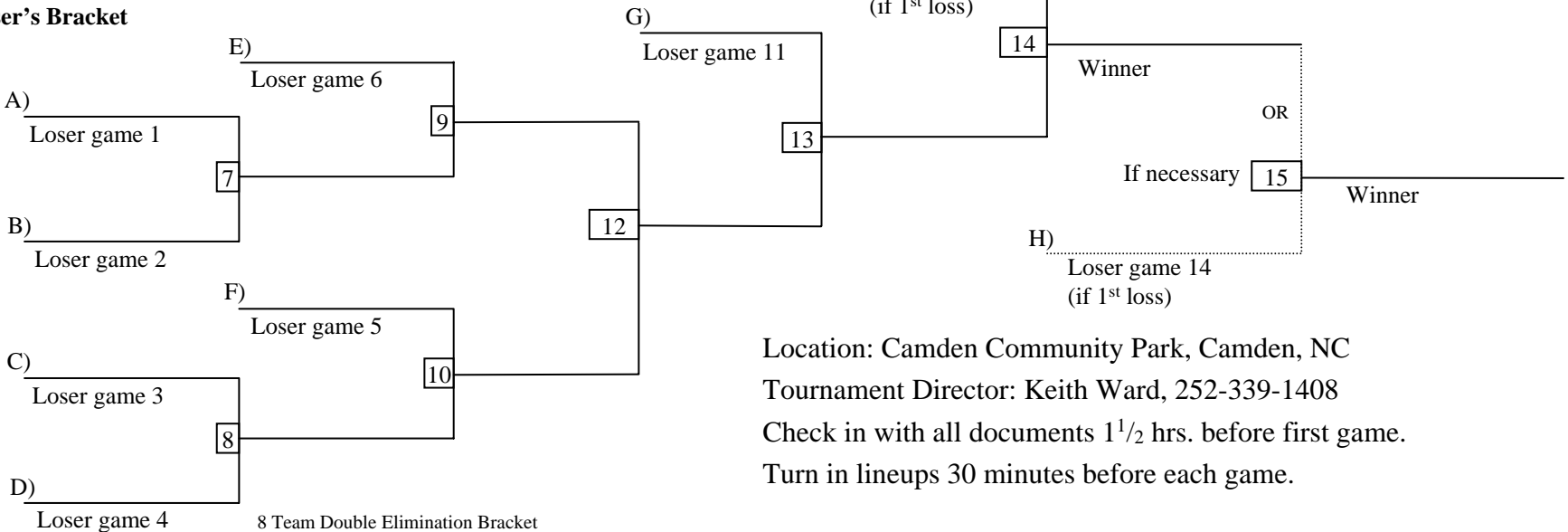

Location: Camden Community Park, Camden, NC  
 Tournament Director: Keith Ward, 252-339-1408  
 Check in with all documents 1½ hrs. before first game.  
 Turn in lineups 30 minutes before each game.

# ENC DISTRICT 7 9 yr. old TOURNAMENT

<u>Game #</u>	<u>Day/Date</u>	<u>Time</u>
Game 1	Wed/7-1	3:30 pm
Game 2	Wed/7-1	5:30 pm
Game 3	Thu/7-2	7:30 pm
Game 4	Fri/7-3	5:30 pm
Game 5	Sun/7-5	TBD

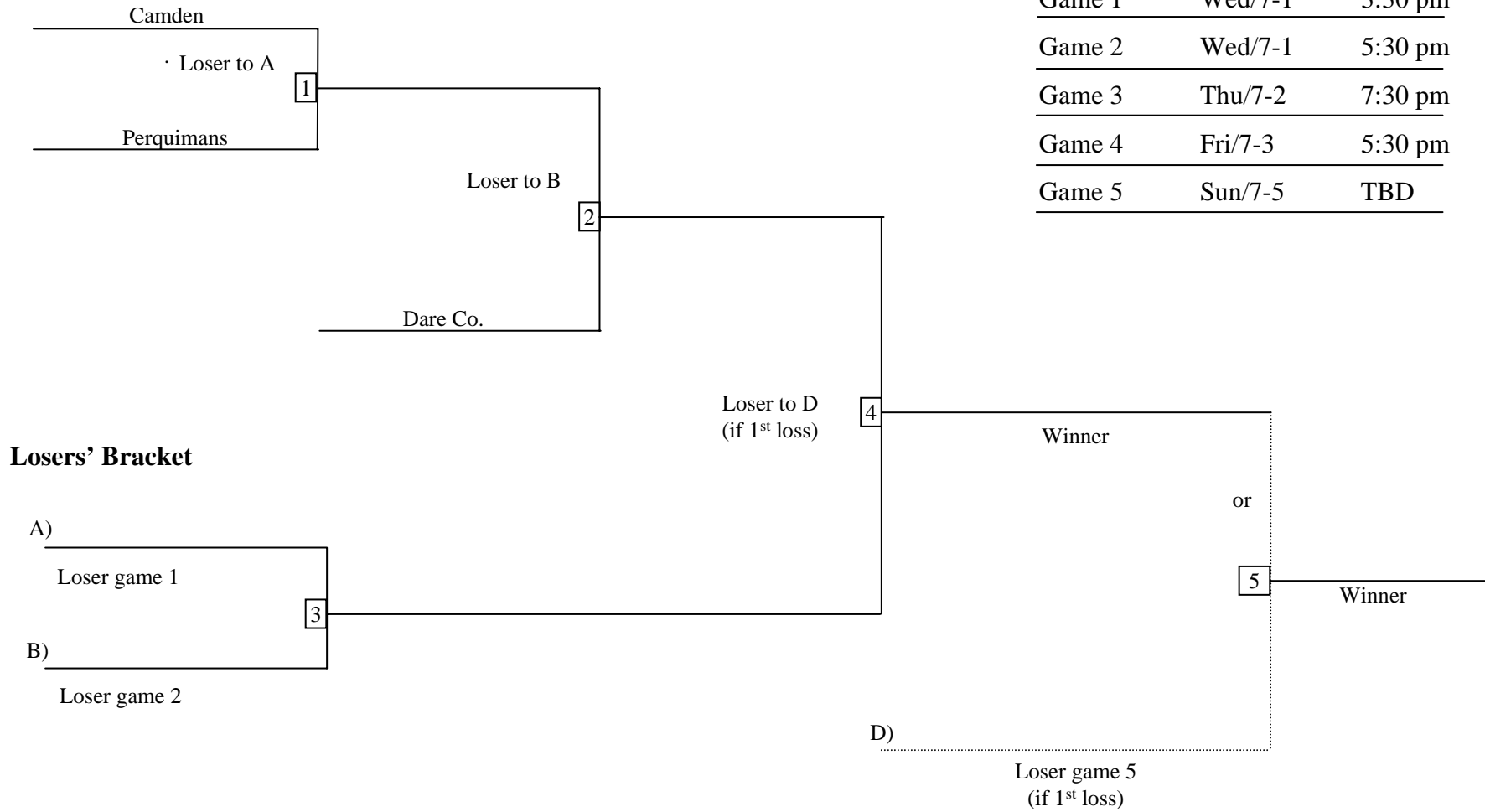

Location: Wescott Park, Manteo, NC

Tournament Director: Missy McPherson, 252-216-6831

Check in with all documents 1½ hrs. before first game.

Turn in lineups 30 minutes before each game.

2009

# ENC DISTRICT 7 10 yr. old CAL RIPKEN TOURNAMENT

## Winner's Bracket

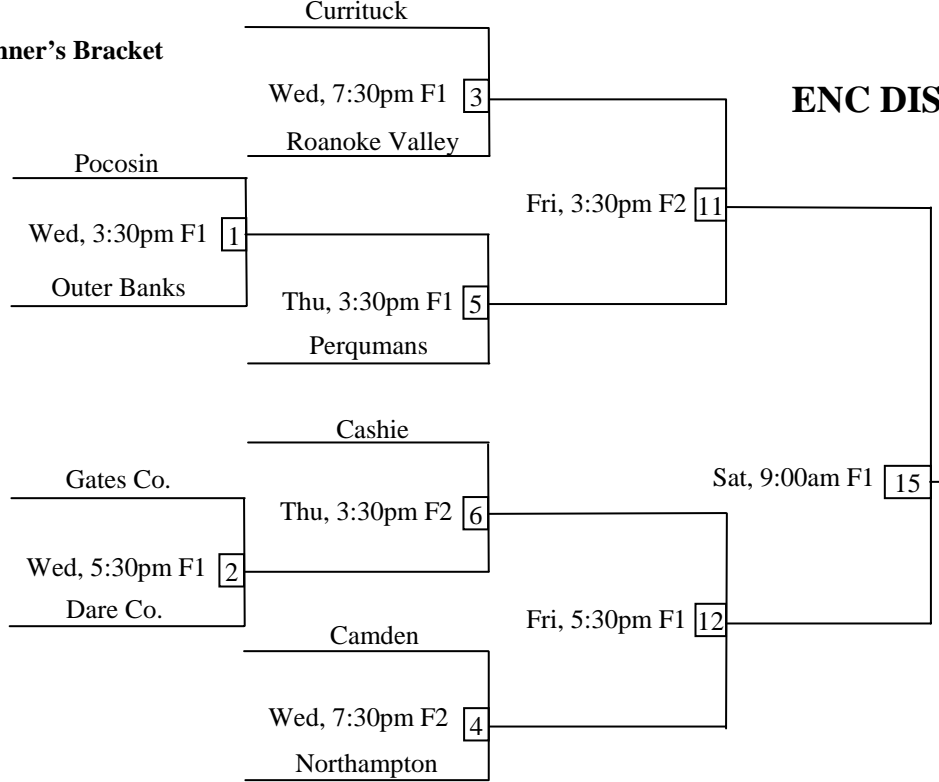

## Loser's Bracket

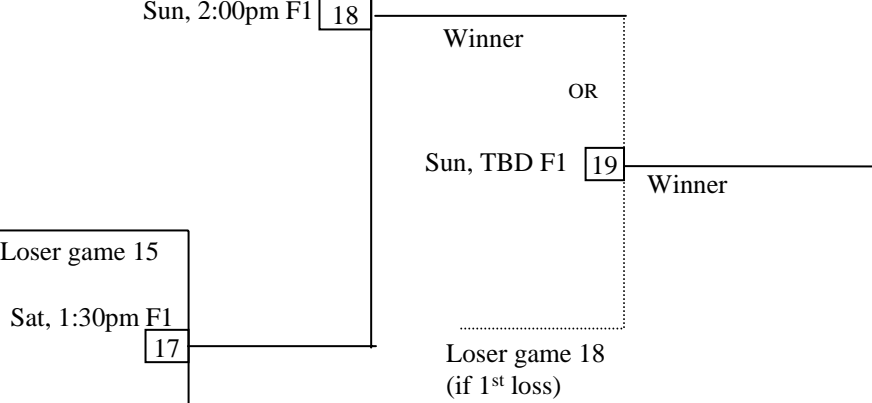
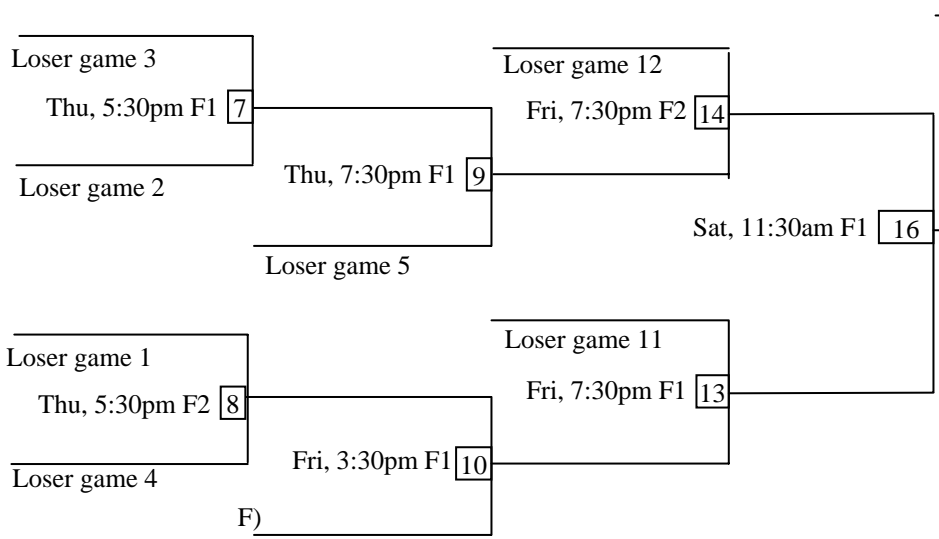

Location: Wescott Park, Manteo, NC  
 Tournament Director: Missy McPherson, 252-216-6831  
 Check in with all documents 1½ hrs. before first game.  
 Turn in lineups 30 minutes before each game.

# ENC DISTRICT 7, 11 yr. old CAL RIPKEN TOURNAMENT

## Winners' Bracket

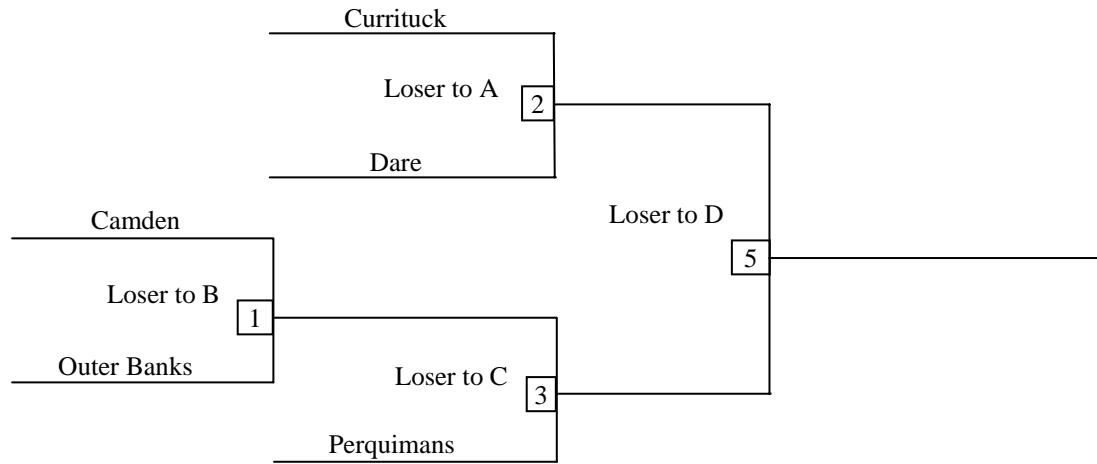

## Losers' Bracket

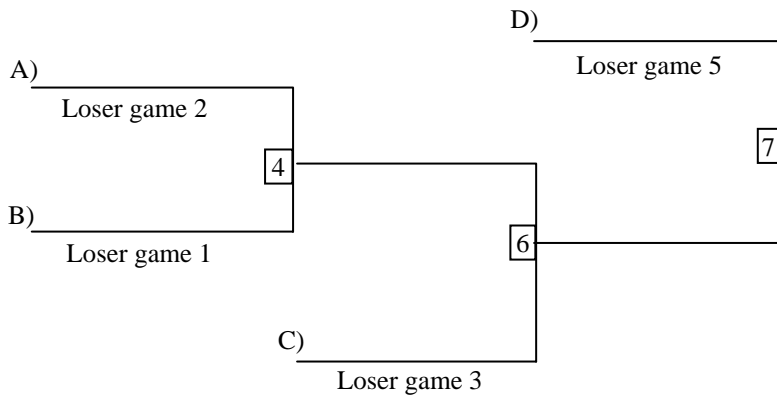

Game #	Day/Date	Time	Field
Game 1	Thu/7-2	1:30 pm	1
Game 2	Thu/7-2	1:30 pm	2
Game 3	Fri/7-3	1:30 pm	1
Game 4	Fri/7-3	1:30 pm	2
Game 5	Sat/7-4	9:00 am	2
Game 6	Sat/7-4	11:30 am	2
Game 7	Sat/7-4	2:00 pm	2
Game 8	Sun/7-5	2:00 pm	2
Game 9	Sun/7-5	TBD	2

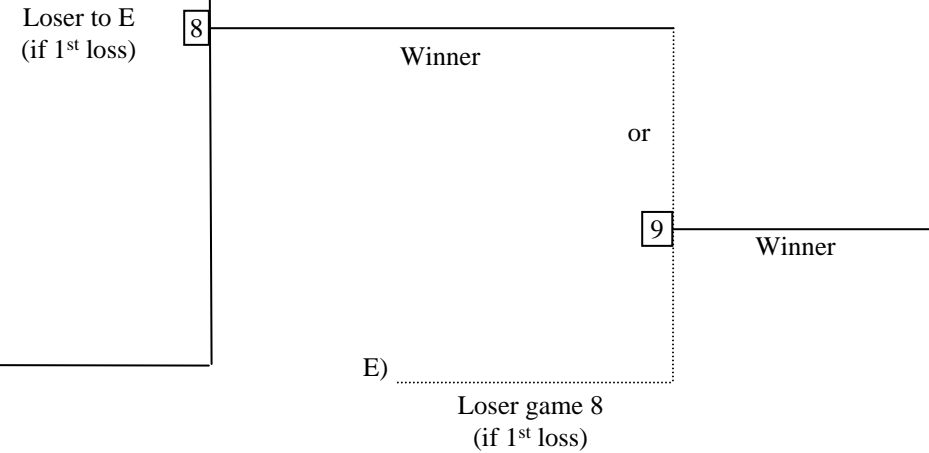

Location: Wescott Park, Manteo, NC

Tournament Director: Tim White, 252-475-5916

Check in with all documents 1½ hrs. before first game.

Turn in lineups 30 minutes before each game.

# ENC DISTRICT 7 12yr. old 46/60 CAL RIPKEN TOURNAMENT

## Winners' Bracket

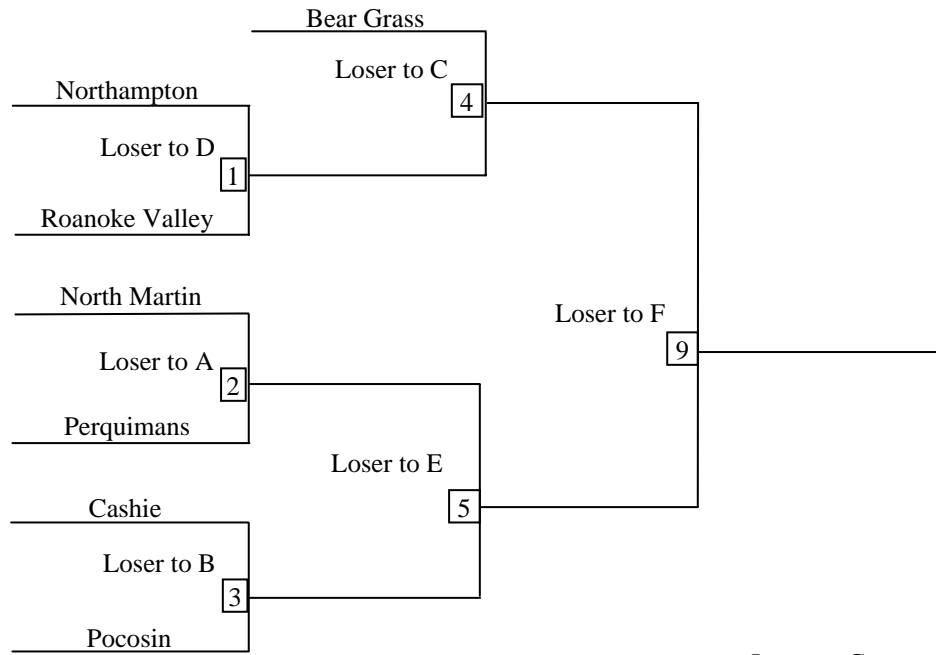

<u>Game #</u>	<u>Day/Date</u>	<u>Time</u>
Game 1	Thu/7-2	11:00 am
Game 2	Thu/7-2	1:00 pm
Game 3	Thu/7-2	3:30 pm
Game 4	Thu/7-2	5:30 pm
Game 5	Fri/7-3	10:00 am
Game 6	Fri/7-3	12:00 noon
Game 7	Fri/7-3	2:30 pm
Game 8	Fri/7-3	4:30 pm
Game 9	Sat/7-4	9:00 am
Game 10	Sat/7-4	11:30 am
Game 11	Sat/7-4	1:30 pm
Game 12	Sun/7-5	2:00 pm
Game 13	Sun/7-5	4:30 pm

## Losers' Bracket

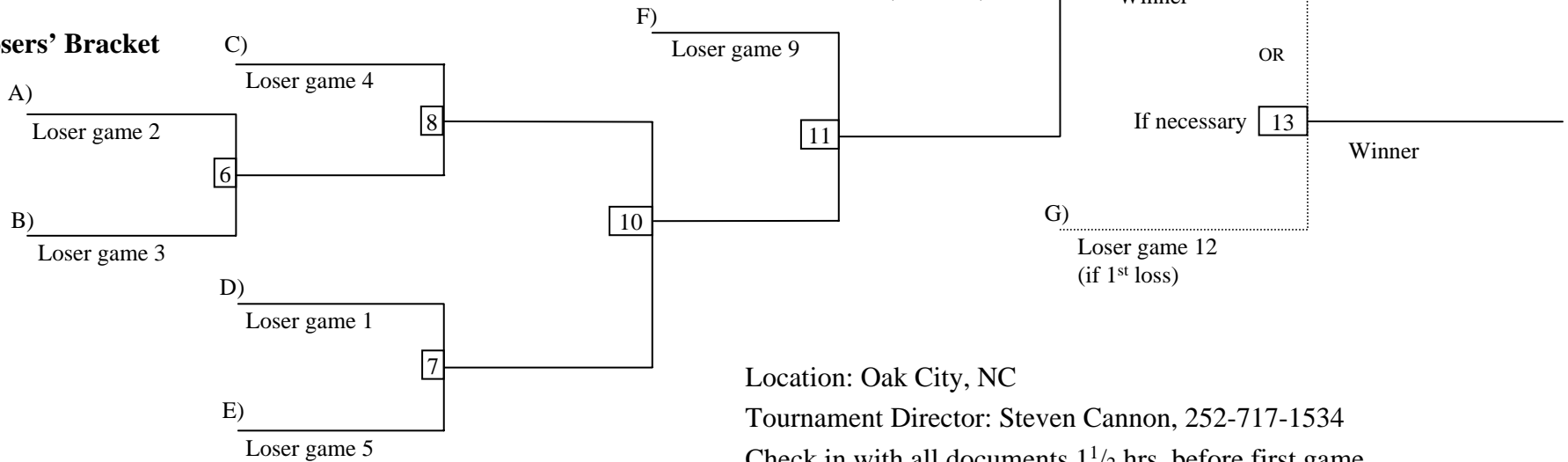

Location: Oak City, NC

Tournament Director: Steven Cannon, 252-717-1534

Check in with all documents 1½ hrs. before first game.

Turn in lineups 30 minutes before each game.

# ENC DISTRICT 7 12 yr. old 50/70 CAL RIPKEN TOURNAMENT

## Winners' Bracket

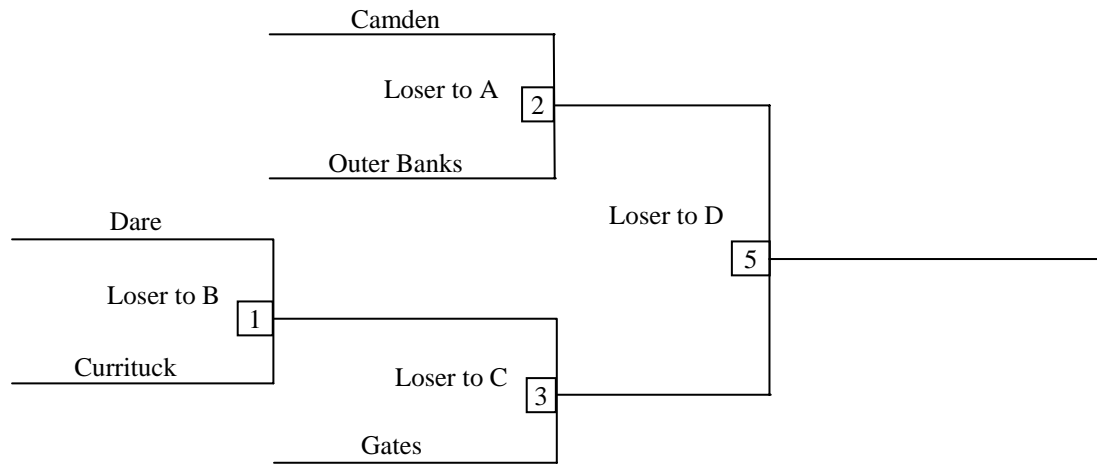

Game #	Day/Date	Time
Game 1	Thu/7-2	5:00 pm
Game 2	Thu/7-2	7:00 pm
Game 3	Fri/7-3	5:00 pm
Game 4	Fri/7-3	7:00 pm
Game 5	Sat/7-4	9:00 am
Game 6	Sat/7-4	11:30 am
Game 7	Sat/7-4	1:30 pm
Game 8	Sun/7-5	2:00 pm
Game 9	Sun/7-5	4:30 pm

## Losers' Bracket

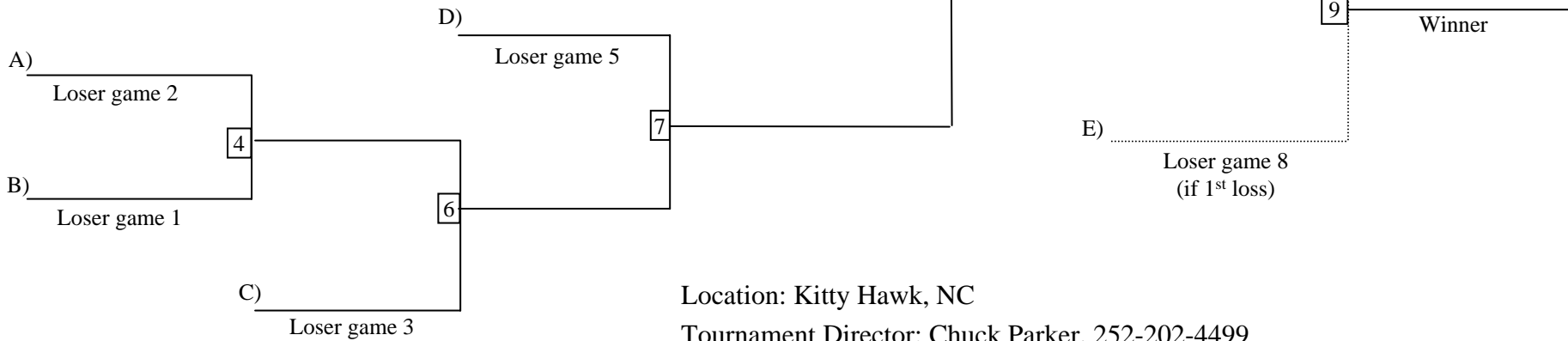

Location: Kitty Hawk, NC

Tournament Director: Chuck Parker, 252-202-4499

Check in with all documents 1½ hrs. before first game.

Turn in lineups 30 minutes before each game.

# ENC District 7 Babe Ruth 13 yr. old Tournament

## Winners' Bracket

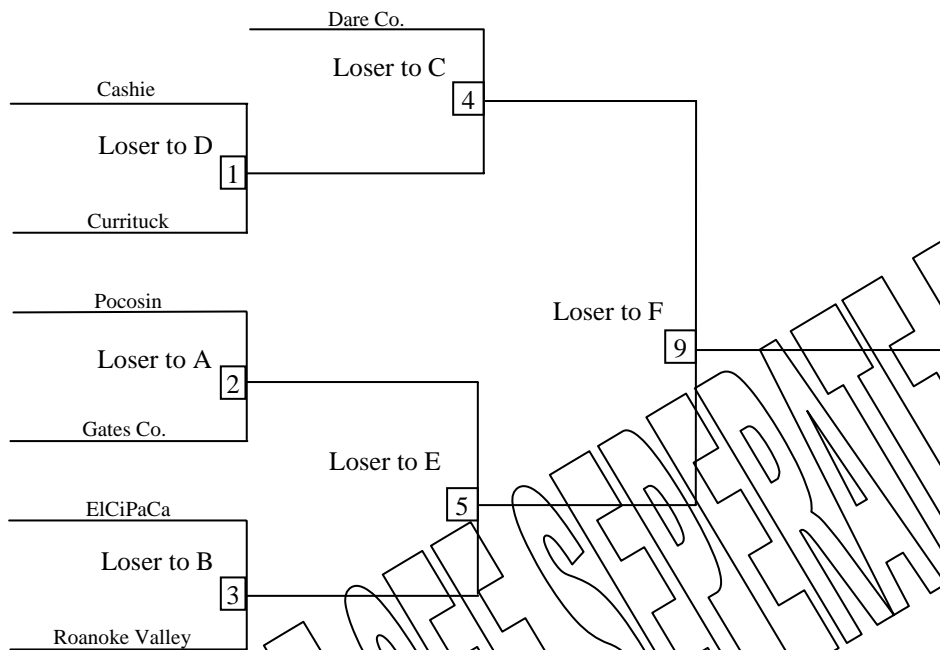

<u>Game #</u>	<u>Day/Date</u>	<u>Time</u>
Game 1	Thu/7-9	10:00 am
Game 2	Thu/7-9	12:30 pm
Game 3	Thu/7-9	3:00 pm
Game 4	Thu/7-9	5:30 pm
Game 5	Fri/7-10	10:00 am
Game 6	Fri/7-10	12:30 pm
Game 7	Fri/7-10	3:00 pm
Game 8	Fri/7-10	5:30 pm
Game 9	Sat/7-11	9:00 am
Game 10	Sat/7-11	11:30 am
Game 11	Sat/7-11	2:00 pm
Game 12	Sun/7-12	2:00 pm
Game 13	Sun/7-12	4:30 pm

## Losers' Bracket

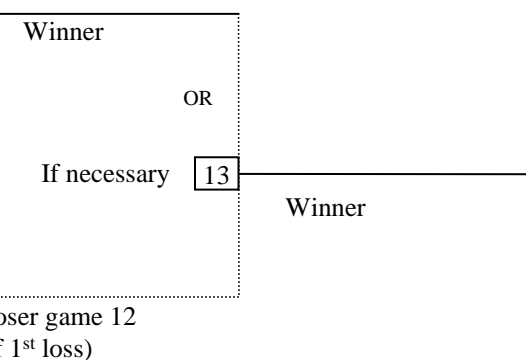
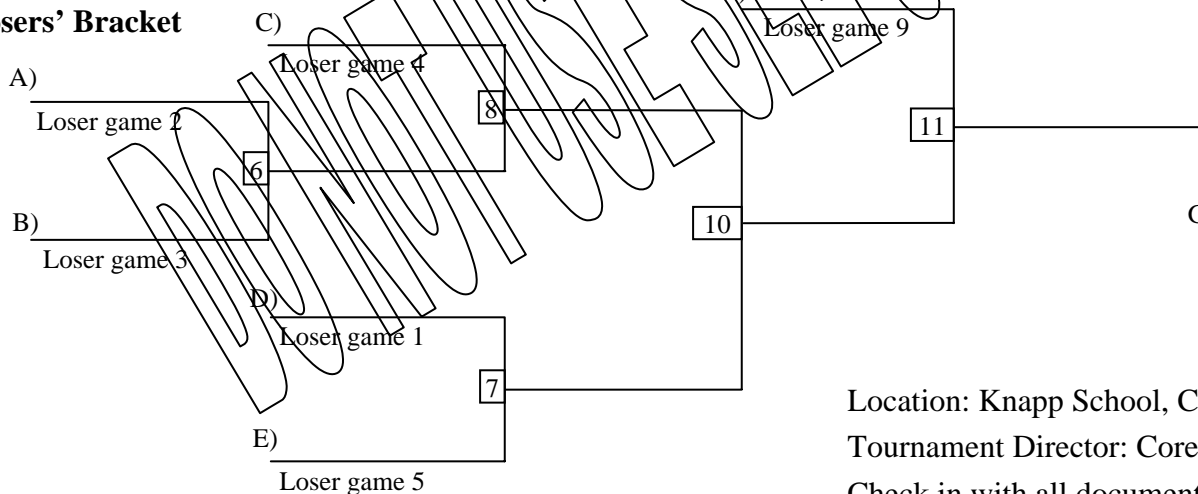

Location: Knapp School, Currituck, NC

Tournament Director: Corey Miller, 252-256-3290

Check in with all documents 1½ hrs. before first game.

Turn in lineups 30 minutes before each game.

# ENC District 7 Babe Ruth 14 yr. old Tournament

## Winners' Bracket

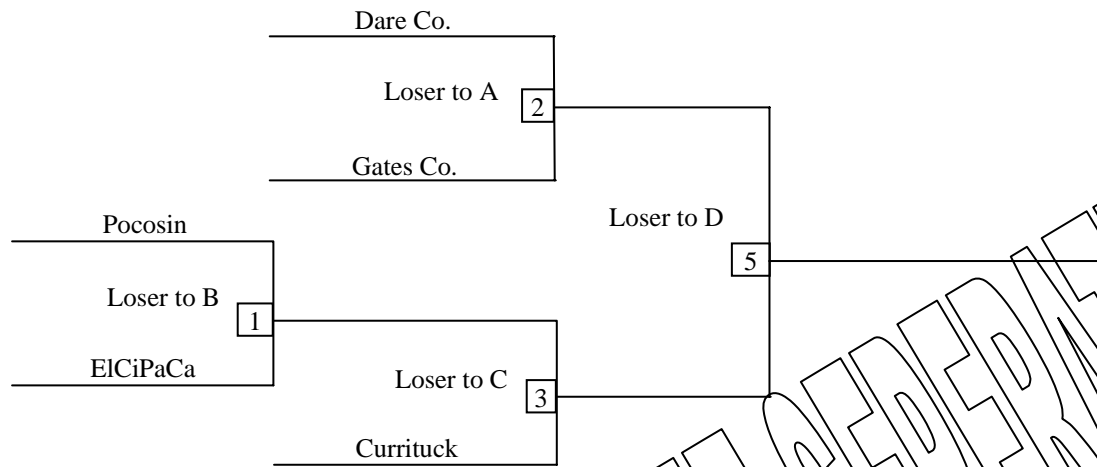

Game #	Day/Date	Time
Game 1	Thu/7-9	5:00 pm
Game 2	Thu/7-9	7:00 pm
Game 3	Fri/7-10	5:00 pm
Game 4	Fri/7-10	7:00 pm
Game 5	Sat/7-11	9:00 am
Game 6	Sat/7-11	11:30 pm
Game 7	Sat/7-11	1:30 pm
Game 8	Sun/7-12	2:00 pm
Game 9	Sun/7-12	4:30 pm

## Losers' Bracket



Location: Dare Co., NC

Tournament Director: Rex Meads, 252-425-4004

Check in with all documents 1½ hrs. before first game.

Turn in lineups 30 minutes before each game.

# ENC District 7 Babe Ruth 13-15 Tournament

<u>Game #</u>	<u>Day/Date</u>	<u>Time</u>
Game 1	Thu/7-9	10:00 am
Game 2	Thu/7-9	12:30 pm
Game 3	Thu/7-9	3:00 pm
Game 4	Thu/7-9	5:30 pm
Game 5	Fri/7-10	10:00 am
Game 6	Fri/7-10	12:30 pm
Game 7	Fri/7-10	3:00 pm
Game 8	Fri/7-10	5:30 pm
Game 9	Sat/7-11	9:00 am
Game 10	Sat/7-11	11:30 am
Game 11	Sat/7-11	2:00 pm
Game 12	Sun/7-12	2:00 pm
Game 13	Sun/7-12	4:30 pm

## Winners' Bracket

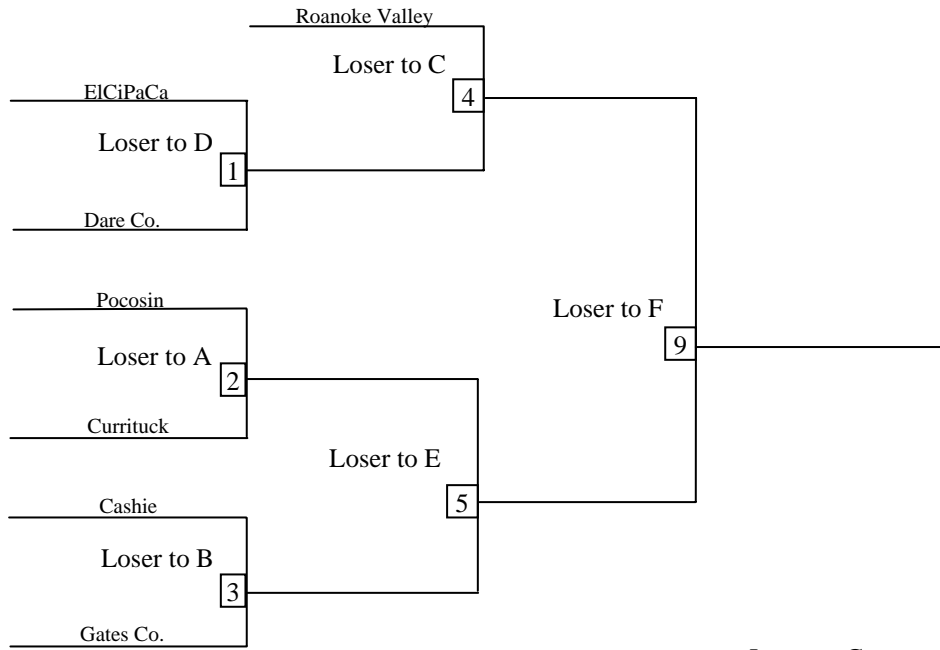

## Losers' Bracket

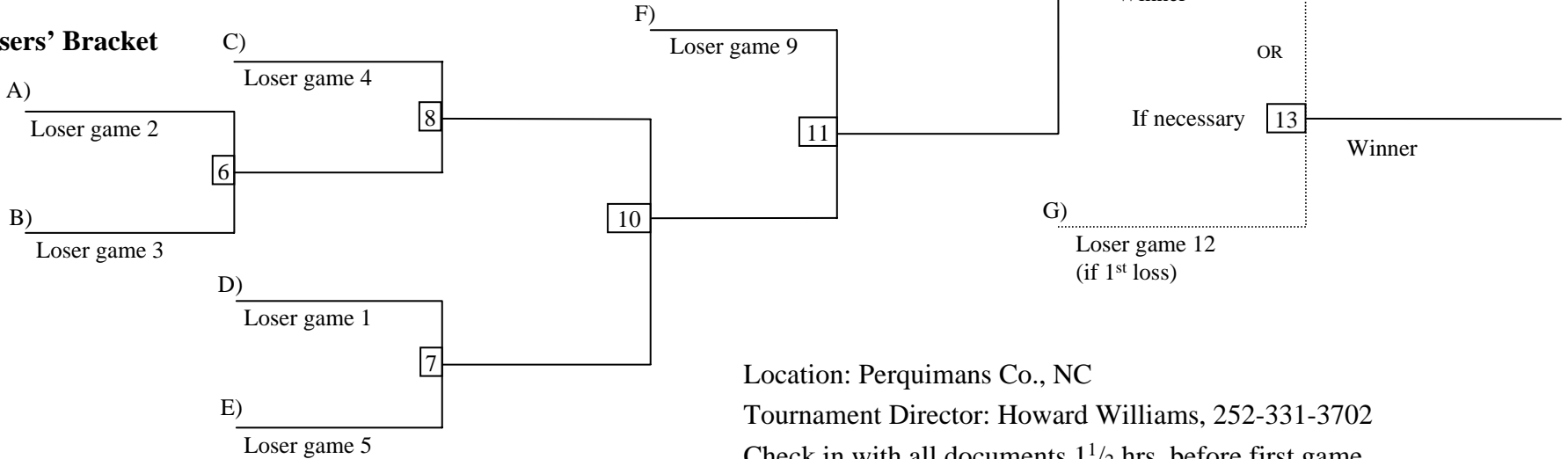

Location: Perquimans Co., NC

Tournament Director: Howard Williams, 252-331-3702

Check in with all documents 1½ hrs. before first game.

Turn in lineups 30 minutes before each game.